

USAGE AREAS:

It is suitable for use in outdoor and indoor sports facilities, concerts and event areas.

SYSTEM DEFINITION:

Produced in accordance with standards, the New Generation Ceremony Folding VIP seat is a floor-mountable system with a durable internal skeleton.



FEATURES:

The foldable Ceremony seat offers comfortable and practical use with its ergonomic design, lightweight portability, easy assembly and durability.

CEREMONY 106

TECHNICAL SPECIFICATIONS

SEAT AND BACK UNITS

- 1 The seating and back units of the seats have an ergonomic design and have been developed in accordance with human anatomy.
- 2 These units are produced with polyurethane material in aluminum molds with a density of 55 kg/m³ +/- 10% and in accordance with Mvss 302 fire standards.
- 3 Inside the seat and back sponges, there is an internal skeleton made of metal profile that increases durability.
- 4 The seating parts of the seats have a center of gravity mechanism with self-closing feature.

CARRIER LEGS AND ARMRESTS

- 1 The foot parts of the seats are made of box profile measuring 40 x 60 x 1.5 mm, and the connection parts to the floor are produced by molding from at least 2 mm thick sheet metal, adding durability.
- 2 Impact-resistant plastic armrests are used in the armrests. The armrests between the rows of seats are shared.
- 3 The seats have double legs and are securely fixed to the floor with suitable fasteners.

FABRIC / FAUX LEATHER

- 1 The fabric and faux leather to be upholstered are resistant to friction, non-flammable, and colorfast.
- 2 The faux leathers to be used in the products have 2% PU, 84% PVC, 7% Polyester, and 7% Cotton content.
- 3 The weight of faux leather is a minimum of 550 gr/m² and its thickness is 1.25 mm.
- 4 Its light fastness is at the level of 7 (ISO 105B02) and its friction resistance is at the level of Class 5 (ISO 105X12).
- 5 Its fire resistance is at BS 5852 (Crib 5) level.
- 6 The seat and back pads of the seats are covered with fabric or faux leather with the specified properties, and impact-resistant, acoustic perforated plastic covers are mounted underneath.



PRODUCT IMAGES



COLOURS



RED



BLUE



GREEN



YELLOW



BURGUNDY



WHITE



BLACK

TECHNICAL DRAWING

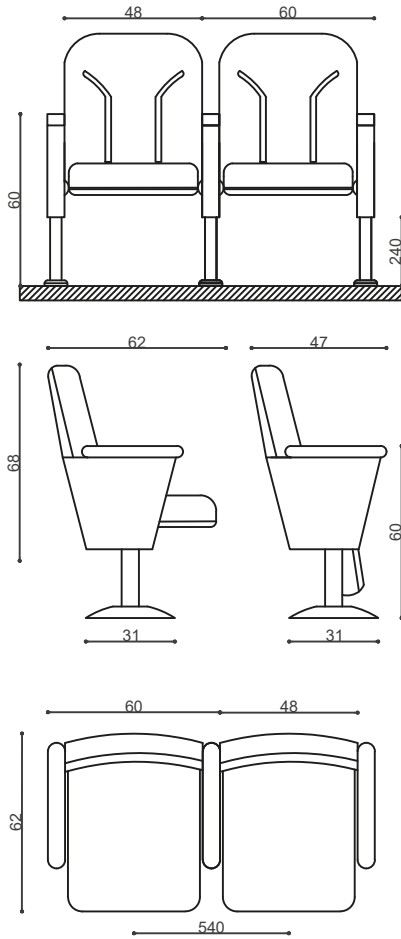

PHOTOS FROM PRODUCTION



CEREMONY 106

APPLICATION AREAS

